

explore 5

User Guide



Humanware™

see things. differently.

QUICK START GUIDE

1. Connect the USB recharge cable to the Power Supply.
2. Hold explorē 5 so that the screen side is facing you. Make sure the tactile USB symbol on the recharge cable's USB connector is on the opposite side of the screen. Carefully connect the cable to the recharge port located on the left side of your

device and plug the power supply into an outlet.

IMPORTANT: Use caution while inserting the cable into the Recharge Port.

3. Let your device recharge until your battery is full. The device will become warmer during the charge – this is normal.
4. Once the device is fully charged, carefully disconnect the power cable.

5. Press the **Power button** to start using the device.

CONTENTS

Chapter 1 – Product Overview	1
Introduction	1
Box Contents	4
Physical Description	5
Chapter 2 – Using your explorē 5	8
Powering off explorē 5	11
Magnifier Mode	11
Zooming in and out	12
Changing Contrast	13

Line and blinds	15
Autofocus	16
Freezing an image	18
Zooming in and out of frozen images....	19
Gallery Mode	20
Capturing and saving images to Gallery.....	20
Accessing and viewing images in Gallery.....	21
Deleting images from Gallery.....	22

Using an external screen	24
Chapter 3 – Exporting images to computer..	25
Chapter 4 – Configuring your explorē 5	27
Accessing, navigating in and changing Settings.....	27
Viewing software/hardware numbers	34
Restoring factory defaults	35
Chapter 5 – Updating your explorē 5	36
Chapter 6 – Recharging your explorē 5	37
Chapter 7 – Troubleshooting.....	43

explorē 5 does not power on.....	43
Screen is black.....	45
explorē 5 shuts down after inactivity	46
Colors are difficult to detect	47
There is a lot of glare	47
Other problems	49
Chapter 8 – Cleaning your explorē 5	50
Cleaning the LCD Screen.....	50
Cleaning the explorē 5 exterior.....	53
Appendix A – Safety Instructions	55

Appendix B – Technical Specifications	58
Appendix C – Customer Support	60
Appendix D – FCC Information	61
Appendix E – Warranty	66

CHAPTER 1 – PRODUCT OVERVIEW

INTRODUCTION

Thank you for purchasing the HumanWare explorē 5, the easy to use, smallest and most portable electronic handheld magnifier with a large easy to read 5” screen.

Being magnifier users ourselves, we at HumanWare know that in addition to the best

available image quality, a good magnifier needs to be simple, portable, comfortable to use, and should always be ready when you need it, where you need it. Your explorē 5 was designed with just that in mind, for we take great pride in offering you a quality product that will meet both your needs and expectations.

Carefully read the operating and safety instructions described in this user guide prior to using your device. If you have any questions about your system, please contact

HumanWare Customer Service by consulting the contact information in the back of this user guide.

Congratulations for your purchase. You'll be reading those fine prints in a matter of seconds.

Copyright 2018 by Technologies HumanWare Inc., all rights reserved. No part of this publication may be reproduced or distributed in any form or by any means, or stored in a database or retrieval system, without the prior written permission of Technologies HumanWare Inc.

BOX CONTENTS

Base box

explorē 5 Electronic Magnifier
Carrying case
Power adapter
USB cable
Lanyard
User Guide
Warranty Sheet
Microfiber cleaning cloth
HDMI Cable

PHYSICAL DESCRIPTION

Front Face

1. Contrast button
2. Zoom+ button
3. Zoom- button
4. Freeze button
5. Attachment ring

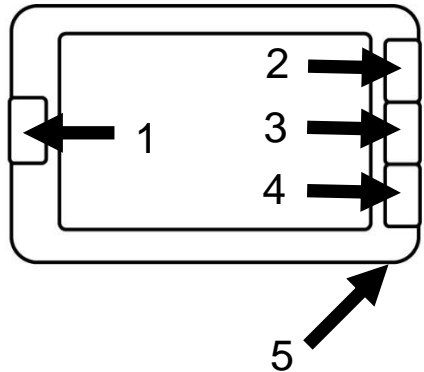

Back Side

1. Power button

2. Camera

3. LEDs

4. Handle

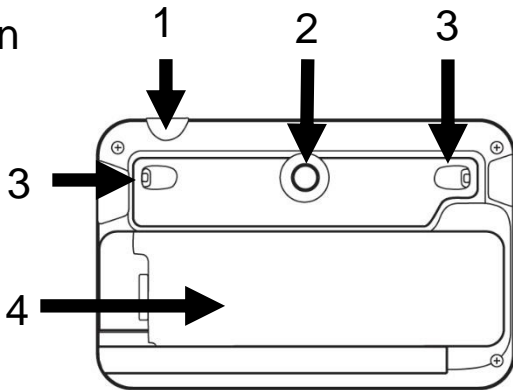

Left Edge

1. USB connector
(for recharge
cable)

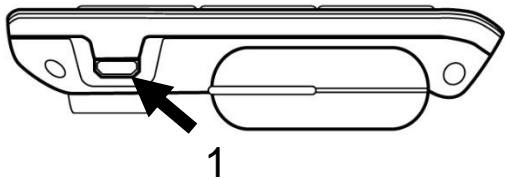

Right Edge

1. HDMI Connector
(for external screen)

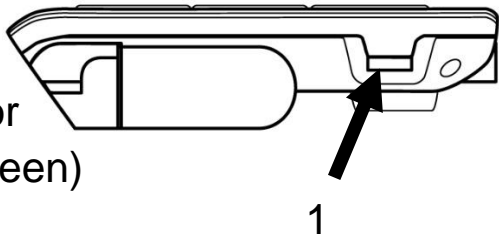

CHAPTER 2 – USING YOUR EXPLORĒ 5

To start your magnifier, simply press the **Power button** located on the top edge of the device, on the right side. The device can then be held by the sides, just like you would hold a tablet.

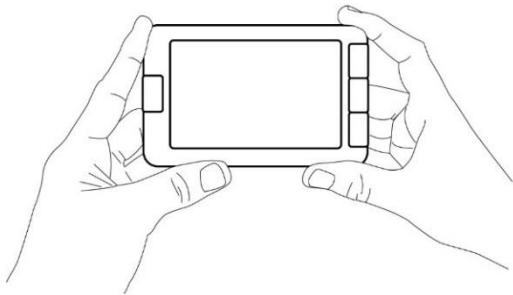

Alternatively, you can turn on your device by simply opening the handle sideways, just like you would hold a magnifier.

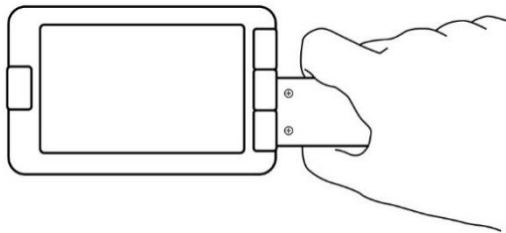

The device could also be used hand-free by opening the handle vertically and placing it over what you wish to read.

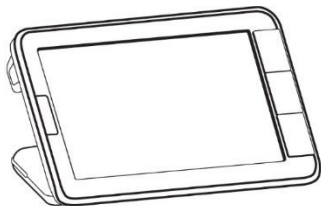

After a few seconds, the explorē 5 screen will open and display the image from the camera. This is the magnifier mode.

POWERING OFF EXPLORĒ 5

To turn off your device, simply press the **Power button**. Alternatively, if your magnifier's handle is open, you can close your device by simply turning the handle back into its closed position.

MAGNIFIER MODE

Magnifier mode is explorē 5's main mode of operation. Simply hold your device over the text or object you wish to magnify to start reading.

ZOOMING IN AND OUT

To zoom in, simply press or press and hold the **Zoom+ button** until the image is of the appropriate size. Similarly, you can zoom out by single pressing or pressing and holding the **Zoom- button** until you are satisfied with the image size.

CHANGING CONTRAST

explorē 5 allows you to customize contrast to better suit your needs and preferences. Simply press the **Contrast button** to change contrast until you find one you are comfortable with.

The available contrast modes are listed below:

- Full color, Black on white, White on black, Black on yellow, Yellow on black

Other contrast modes are also available:

- Black on orange, Orange on black, Black on cyan, Cyan on black, Black on purple, Purple on black, Black on green, Green on black, Blue on yellow, Yellow on blue, White on blue, Blue on white.

It is possible to select the favorite contrast mode in the settings menu.

LINE AND BLINDS

With the explorē 5, you can add a horizontal line or blinds over your image for easier reading.

To add or remove a line, press and hold the **Contrast** and **Zoom+** buttons simultaneously.

To add or remove blinds, press and hold the **Contrast** and **Zoom-** buttons simultaneously.

AUTOFOCUS

explorē 5 features an autofocus that can be set to **locked** or **unlocked** from the menu.

When autofocus is set to **unlocked** (by default), explorē 5 will dynamically adjust its focus to the object currently being viewed.

When autofocus is set to **locked**, and you are using your magnifier on a tabletop, explorē 5 will maintain its current focus regardless of any movements or changes.

When autofocus is set to **locked**, and you are holding your magnifier like a tablet or with the handle, explorē 5 will maintain its focus approximately 6 cm in front of the magnifier.

Note: To reset the focus when autofocus is set to **locked**, simply press the **Freeze button** once to freeze the image, then press the **Freeze button** again to return to the magnifier mode.

Note: Autofocus is set to locked by default in stand mode.

FREEZING AN IMAGE

explorē 5 enables you to freeze an image while in magnifier mode for easier reading, an especially useful feature when reading labels or writings on products on stores' top shelves. To freeze an image, simply press the **Freeze button** while aligning your magnifier towards what you wish to read. This will take a snapshot

of what your device was oriented towards. The snapshot will be displayed on your screen until you decide to return to Magnifier mode.

To return to magnifier mode, simply press the **Freeze button** once again.

ZOOMING IN AND OUT OF FROZEN IMAGES

To zoom in on still images, simply press or press and hold the **Zoom+ button** until the

image is of the appropriate size. Similarly, you can zoom out by single pressing or pressing and holding the **Zoom- button** until you are satisfied with the image size.

GALLERY MODE

CAPTURING AND SAVING IMAGES TO GALLERY

To save a live or static image to your Gallery, simply press and hold the **Freeze button** for a

half-second while in Magnifier mode. You should see a Save message displayed briefly on your screen meaning your image is now saved inside explorē 5's Gallery.

ACCESSING AND VIEWING IMAGES IN GALLERY

You can access explorē 5's Gallery through the menu. Alternatively, you can access the Gallery by simply pressing and holding the **Freeze** and

Contrast buttons simultaneously while in Magnifier mode.

You can navigate the Gallery by pressing the **Zoom+** and **Zoom-** buttons.

To exit the Gallery, simply press the **Contrast button**.

DELETING IMAGES FROM GALLERY

To delete an image from the Gallery, access the Gallery by pressing and holding the **Freeze**

and **Contrast buttons** simultaneously while in Magnifier mode.

Navigate to the image you wish to delete (by pressing the **Zoom+** and **Zoom- buttons**), then press and hold the **Freeze button** to delete the image.

To confirm the deletion of an image, select Delete by pressing the **Zoom+** button. You can cancel by either selecting cancel with the **Zoom-** button.

If you wish to delete all your images at once, you can do so by entering the menu and selecting Delete Gallery content.

USING AN EXTERNAL SCREEN

For a larger image, you may want explorē 5's content to be displayed on an external screen (like a TV). To do so, simply connect your explorē 5 to an external screen using an HDMI cable. Please refer to Appendix B for a list of supported HDMI formats.

Note: You will need to restart your explorē 5 after unplugging your HDMI cable for it to recharge.

CHAPTER 3 – EXPORTING IMAGES TO COMPUTER

To export Gallery images saved on explorē 5 to your computer, connect your magnifier to your computer with the USB cable provided. You should see a “PC connected” message appear

on your device. You can now copy and paste the images from your Gallery to your computer using your computer's file browser.

When connected to a personal computer, the device will act exactly like a USB thumb drive or an external drive. Gallery images are located in the Images folder on your explorē 5.

When you are copying or deleting images from the device, never disconnect the USB cable as some images could be lost in the process.

CHAPTER 4 – CONFIGURING YOUR EXPLORE 5

ACCESSING, NAVIGATING IN AND CHANGING SETTINGS

Press and hold the **Contrast button** to enter the menu. You can navigate the menu by pressing the **Zoom+ button** to scroll up and the **Zoom- button** to scroll down.

To select an item, press the **Freeze button**. To go back to the previous menu, press **Contrast**, or press and hold **Contrast** to return to the Magnifier mode.

The menu contains the following items:

- **Gallery** (Access Gallery images)
- **Autofocus:** Unlocked*, Locked (Locked* in stand mode)

- **Screen Brightness** (Change the screen's brightness level): 1 to 9 (8*)
- **Auto-off** (Choose how long the device stays on): 1 minute, 2 minutes, 5 minutes*, 10 minutes
- **Preferred Zoom** (Change the default zoom level when you open your device): Previous (the zoom level you were at when you closed your device), 2x* to 22x

- **Contrast (submenu)**
 - **Preferred Contrast** (select contrast in which your explorē 5 starts up): Previous* (last used contrast), Color, enabled contrasts
 - **Menu** (change menu colors): Black on white, White on black, Black on yellow, Yellow on black, Black on orange, Orange on black, Black on cyan, Cyan on black, Black on purple, Purple on

black, Black on green, Green on black,
Blue on yellow, Yellow on blue, White
on blue, Blue on white

- **Enabled contrasts** (select enabled color pairs for magnifier mode): Black on white, White on black, Black on yellow, Yellow on black, Black on orange, Orange on black, Black on cyan, Cyan on black, Black on purple, Purple on black, Black on green, Green

on black, Blue on yellow, Yellow on blue, White on blue, Blue on white

- **Lights:** On*, Low, Off
- **Language:** English (US)*, English (UK), French, Spanish, German, Dutch, Danish, Polish, Portuguese (Portugal), Portuguese (Brazil), Norwegian (Bokmål), Italian, Swedish, Finnish, Russian, Czech, Japanese, Korean, Icelandic, Estonian, Turkish, Lithuanian, Hungarian, Latvian,

Arabic, Chinese (simplified), Chinese (traditional), Hebrew, Georgian, Farsi, Kurdish

- **Display:** 50Hz , 60Hz*
- **Delete Gallery**
- **Factory Defaults**
- **About** (View/Set information about your device): Date and time, Software, Hardware, Serial

VIEWING SOFTWARE/HARDWARE NUMBERS

To see explorē 5's software and hardware version, access the menu by pressing and holding the **Contrast button**.

Scroll down to About by pressing **Zoom-** then press the **Freeze button** to display explorē 5's current software and hardware versions.

RESTORING FACTORY DEFAULTS

To restore your magnifier to factory defaults, access the menu by pressing and holding the **Contrast button**. Scroll down to Factory Defaults by pressing **Zoom-** then press the **Freeze button**. Select Yes and press **Freeze** again to confirm.

CHAPTER 5 – UPDATING YOUR EXPLORĒ 5

Go to:

<http://www.humanware.com/support/explore5>

and download the latest version of the explorē 5 software. Connect your device to your computer using the provided USB cable. Using your computer's file explorer, paste your downloaded file directly into your explorē 5 root. When the transfer is completed, unplug your

USB cable from your computer. Start your explorē 5. Your device should automatically update itself.

CHAPTER 6 – RECHARGING YOUR EXPLORĒ 5

IMPORTANT: The battery becomes warm during recharging. This is normal. Do not recharge the battery near a heat source.

To recharge the battery using a household power outlet:

- Connect the USB Recharge Cable to explorē 5's Power Supply. Then, carefully connect the USB Recharge Cable to the magnifier and plug the Power Supply to an outlet.
- Let your device charge until your battery is full. It should take approximately 3.5 hours to recharge an empty device.

To recharge the battery with a computer:

- Connect the USB Recharge Cable to your magnifier's Power Supply.

During the recharge process, the image below will show momentarily when the battery starts charging or when the device is turned on.



The lightning bolt icon means your device is being charged. The number to the right represents the percentage of battery charge remaining.

Due to lower voltage, charging from the computer USB may be slower. In some cases, the magnifier may not charge at all depending on the amount of power supplied by the computer. The most effective way to recharge the device is to use the supplied USB cable

connected to the power adapter to recharge the magnifier from a household power outlet.

Although it may lengthen the charging time, the device can be used when it is recharging.

Please note that if the battery is fully discharged or hasn't been used for a very long period, there will be a delay of up to a few minutes before the device shows any activity. This is normal.

Also note that like all electronic devices, your explorē 5 will become warm when in use or

when being charged – this is normal. Although there are no risks, it is recommended to avoid prolonged contact with the grey back plate that acts as a heat sink.

Battery safety precautions:

- Do not disassemble or modify the battery.
- Use only the specified HumanWare charger.
- There is a risk of overheating, fire or explosion if the battery is put in a fire,

heated, subjected to impact, put in contact with water, or if its terminals are shorted.

CHAPTER 7 – TROUBLESHOOTING

EXPLORE 5 DOES NOT POWER ON

Press and hold the **Power button**. If the unit still does not turn on, your device's battery may need recharging.

Connect the provided USB cable with the power supply into a power outlet or just the USB cable into a running computer. If the battery was completely discharged, it may take a few minutes before the device shows any signs of activity.

See **Chapter 6** for additional details.

SCREEN IS BLACK

If the unit is laying on a table or any flat surface, the image may be black. Lift your magnifier to see whether this is the reason why your screen is black.

If this does not solve the problem, try restarting your device.

EXPLORĒ 5 SHUTS DOWN AFTER INACTIVITY

This is a normal behaviour intended to preserve the battery. By default, explorĒ 5 will shut down after 5 minutes of inactivity. It is possible to configure the default auto-shutdown timer to 1 minute, 2 minutes, 5 minutes or 10 minutes.

COLORS ARE DIFFICULT TO DETECT

First make sure there is sufficient ambient light around you.

Choose a different color combination by pressing the **Contrast button** while in magnifier mode.

THERE IS A LOT OF GLARE

Tilt the object you are looking at in a different direction to reduce glare.

EXPLORE 5 DOES NOT RESPOND

Make sure explore 5 is not connected to power via USB cable; if it is, unplug it. Press the Power button for 10 seconds. The system will shut down. Then, press the Power button for one second to turn explore 5 back on.

OTHER PROBLEMS

Restore to factory defaults in the menu.

Access the menu by pressing and holding the **Contrast button**.

Scroll down to Factory Defaults by pressing **Zoom-** then press **Freeze** to restore to factory defaults. Select Yes and press **Freeze** again to confirm.

CHAPTER 8 – CLEANING YOUR EXPLORĒ 5

CLEANING THE LCD SCREEN

Make sure your device is off and unplugged.

Make sure you only use microfiber cloths like the one included with your explorē 5.

Carefully and gently wipe the microfiber cloth across the LCD screen.

If you choose to clean your LCD screen with a liquid cleaner, make sure this cleaner is appropriate for LCD screens. Distilled water, isopropyl alcohol and a vinegar-water solutions (no more than 10% vinegar) are safe cleaning liquids for your LCD screen.

Use only the minimal amount of liquid to prevent spills inside the device. If liquid seeps in, damages to the device might occur. Make sure no liquids remain on your screen. Repeat

the previous steps for spots that are harder to remove.

Never use household cleaners to clean your explorē 5.

Never spray any liquid directly on your LCD screen.

Never use cleaning products that contain ethyl alcohol, ethyl acid, ammonia, acetone or methyl chloride.

Never use paper towel to clean your LCD screen.

CLEANING THE EXPLORÉ 5 EXTERIOR

Make sure your device is off and unplugged.

If necessary, use a slightly humid cloth to clean your device's exterior.

Make sure no liquids remain on your device. Repeat the previous steps for spots that are harder to remove.

Never use abrasive material, sprays, alcohol or solvents to clean your explorē 5 exterior.

APPENDIX A – SAFETY INSTRUCTIONS

You must not stare at the LED light source located on the back side of the magnifier.

Keep away from water or high humidity. Do not submerge.

Power off your explorē 5 before cleaning it.

Use only cables provided with your explorē 5.

Battery:

The explorē 5 has an internal rechargeable Li-Ion battery. The battery must be replaced by a qualified HumanWare technician.

- Do not use or leave the unit near heat source and fire. Do not store in high temperatures.
- Only use USB-compliant power supplies to charge the battery.
- Do not disassemble or modify the unit.
- Do not immerse the unit in water, do not allow it to get wet.

- Do not strike or throw the unit.
- Do not pierce or strike the unit with sharp objects or a hammer.
- If the battery leaks and liquid gets into the eyes, do not rub eyes. Instead, rinse the eyes with clean running water and seek immediate medical attention to prevent injury.
- If the battery leaks and comes into contact with skin, immediately rinse area with clean running water to prevent injury.

APPENDIX B – TECHNICAL SPECIFICATIONS

Size: 89 x 139.4 x 21.3mm

Display: 5” WVGA (800 x 480) LCD

Weight: 228g

Power Input: Micro USB connector, 5V. Max current 1.5A

Battery life: 3 hours

Charge Time: 3.5 hours (when device is off),
4.75 hours (when device is on)

HDMI Compatibility:

Supported HDMI formats:

1280x720p 60Hz, 50Hz

1920x1080p 60Hz, 50 Hz, 24Hz

1920x1080i 60Hz, 50Hz

No support of DVI emulation.

Operating conditions:

Temperature: 10 °C to 40 °C / 50 °F to 104 °F

Humidity: 20% to 80%

Transport and storage conditions:

Temperature: -20 °C to 60 °C / -4 °F to 140 °F

Humidity: 10% to 95%

APPENDIX C – CUSTOMER SUPPORT

For customer support, please contact the HumanWare office nearest you.

Global: support@humanware.com

North America: 1 (800) 722-3393

us.support@humanware.com

Europe: (0044) 1933 415 800

eu.support@humanware.com

Australia / Asia: (02) 9686 2600

au.sales@humanware.com

APPENDIX D – FCC INFORMATION

FCC Statement:

This device complies with part 15 of the FCC Rules. Operation is subject to the following two conditions: (1) This device may not cause harmful interference, and (2) this device must

accept any interference received, including interference that may cause undesired operation.

FCC Warning:

Changes or modifications not expressly approved by the party responsible for compliance could void the user's authority to operate the equipment.

Note: This equipment has been tested and found to comply with the limits for a Class B

digital device, pursuant to part 15 of the FCC Rules. These limits are designed to provide reasonable protection against harmful interference in a residential installation. This equipment generates, uses and can radiate radio frequency energy and, if not installed and used in accordance with the instructions, may cause harmful interference to radio communications. However, there is no guarantee that interference will not occur in a particular installation. If this equipment does

cause harmful interference to radio or television reception, which can be determined by turning the equipment off and on, the user is encouraged to try to correct the interference by one or more of the following measures:

- Reorient or relocate the receiving antenna.
- Increase the separation between the equipment and receiver.

—Connect the equipment into an outlet on a circuit different from that to which the receiver is connected.

—Consult the dealer or an experienced radio/TV technician for help.

Note: This unit was tested with shielded cables on the peripheral devices. Shielded cables must be used with the unit to ensure compliance.

APPENDIX E – WARRANTY

HumanWare warrants explorē 5, effective from the date of purchase, to be free of any defects in material and workmanship for a period of 2 years unless otherwise required by law in the country or region of purchase.

This warranty is non-transferable and applies to all cases where the damage is not a result of improper use, mistreatment, or negligence. Improper use is use of this device other than

described in this manual. In no event shall HumanWare or its distributors be liable for indirect or consequential damages.

No replacement or repair covered by the warranty will be carried out unless the system is accompanied by a copy of the original bill of purchase. Please keep your original receipt. If the system has to be returned, please use the original packaging.

[End of document VER-16-2018-03-27]

Customer support

For customer support, please contact the HumanWare office nearest you or visit our Website at: www.humanware.com

Global: support@humanware.com

North America: 1 (800) 722-3393
us.support@humanware.com

Europe: (0044) 1933 415 800
eu.support@humanware.com

Australia / Asia: (02) 9686 2600
au.sales@humanware.com

Humanware[™]
see things. differently.

ACCD-0137
REV 10