

User Guide



Boombox with Cassette/CD Player/AM/FM Radio

NS-BCDCAS1

Before using your new product, please read these instructions to prevent any damage.

Insignia NS-BCDCAS1 Boombox with Cassette/CD/ AM/FM Radio

Contents

Welcome	3
Safety information	3
Features	5
Setting up your boombox	10
Using your boombox	12
Troubleshooting	17
Maintaining	18
Legal notices	19

Welcome

Congratulations on your purchase of a high-quality Insignia product. Your NS-BCDCAS1 represents the state of the art in boomboxes and is designed for reliable and trouble-free performance.

Safety information

To prevent fire or shock hazard, do not plug the power adapter into an extension cord, receptacle, or other outlet unless the blades can be fully inserted to prevent blade exposure. To prevent fire or shock hazard, do not expose this boombox to rain or moisture.

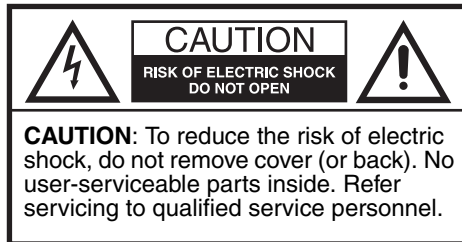

Surge protectors:

We recommend that you use a surge protector when you use the AC adapter with this boombox. Lightning and power surges ARE NOT covered under the warranty for this product.



The lightning flash with arrowhead symbol within a triangle is intended to alert you to the presence of uninsulated dangerous voltage within your boombox's enclosure that may be of sufficient magnitude to constitute risk of electric shock to persons.



The exclamation point within a triangle is intended to alert you to the presence of important operating and maintenance (servicing) instructions in the literature accompanying your boombox.

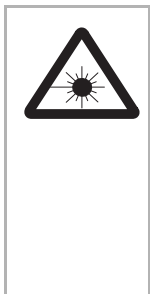

Your boombox utilizes a Class 1 laser to read Compact Discs. Your boombox is equipped with safety switches to avoid exposure when the CD door is open and the safety interlocks are defeated. Invisible laser radiation is present when the CD door is open and the system's interlock has failed or been defeated. You should avoid direct exposure to the laser beam at all times. Do not attempt to defeat or bypass the safety switches.

Warning

To reduce the risk of fire or electric shock, do not expose your boombox to rain or moisture.

Warning

Any use of the controls or an adjustment to the procedures other than those specified herein may result in hazardous radiation.

Caution

Any change or modification to your boombox not expressly approved by Insignia or its authorized parties could void your authority to operate your boombox.

Caution

Your boombox should not be exposed to water (dripping or splashing) and no objects filled with liquids, such as vases, should be placed on it.

Read instructions

Read all the safety and operating instructions before you use your boombox.

Retain instructions

Retain safety and operating instructions for future reference.

Follow warnings and instructions

Follow all warnings on your boombox and in the operating instructions. Follow all operating and use instructions.

Placement

When placing your boombox on a lacquered or natural finish, protect your furniture with a cloth or other protective material.

Avoid exposure to direct sunlight, temperature extremes, and moisture.

Ventilation

Slots and openings in the cabinet and the back or bottom are provided for ventilation, reliable operation, and protection from overheating. These openings must not be blocked or covered. Do not block the openings by placing your boombox on a bed, sofa, rug, or other similar surface.

Water and moisture

Do not use your boombox near water. For example, do not use it near a bath tub, wash bowl, kitchen sink, or laundry tub, in a wet basement, or near a swimming pool.

Do not let water splash or drip onto your boombox. Do not place objects containing liquids, such as a vase, on top of your boombox.

The AC power adapter is used as the disconnect device. It should remain readily accessible and should not be obstructed during use. To completely disconnect power, the AC power adapter should be unplugged from the AC power outlet completely.

The marking plate of the AC adapter is located on the bottom of the adapter.

Features

Package contents:

- Boombox
- AC power adapter
- *User Guide*
- *Quick Setup Guide*

Front panel

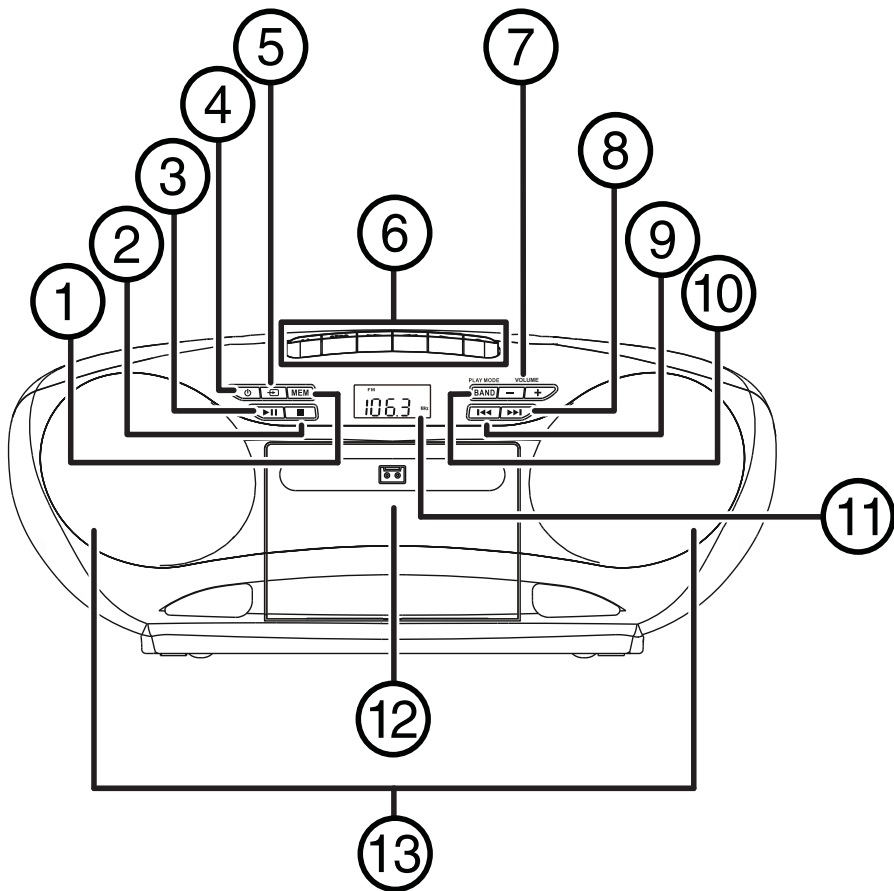

#	Description	Function
1	MEM button	In radio mode, press to create/select preset stations.
2	■ (stop) button	Press to stop playback.
3	▶ (play/pause) button	Press to begin CD playback. Press again to pause playback.
4	⏻ Standby/ON button	Press to turn on your boombox. Press again to return your boombox to standby mode.
5	📻 (source) button	Press to select the sound source (RADIO , CD , TAPE , or AUX).
6	Cassette tape control buttons	These buttons control tape playback. See Top panel below for additional information.

#	Description	Function
7	VOLUME $-/+$ button	Press to lower or raise the volume.
8	▶▶ (next) button	In radio mode, press to tune to the next higher station. In CD mode, press to search/skip to the next track.
9	◀◀ (previous) button	In radio mode, press to tune to the next lower station. In CD mode, press to search/skip to the previous track.
10	BAND/PLAY MODE button	In radio mode, press to select the radio band (AM or FM). In CD mode, press to cycle through the playback modes (repeat 1 , repeat all , or random).
11	Display	Shows radio band, playback mode, program mode, source, volume level, and radio frequency. For additional information, see "Display."
12	Cassette door	Open to insert a cassette tape into the boombox for playback.
13	Left and right speakers	Produce sound so you can listen to your boombox.

Top panel

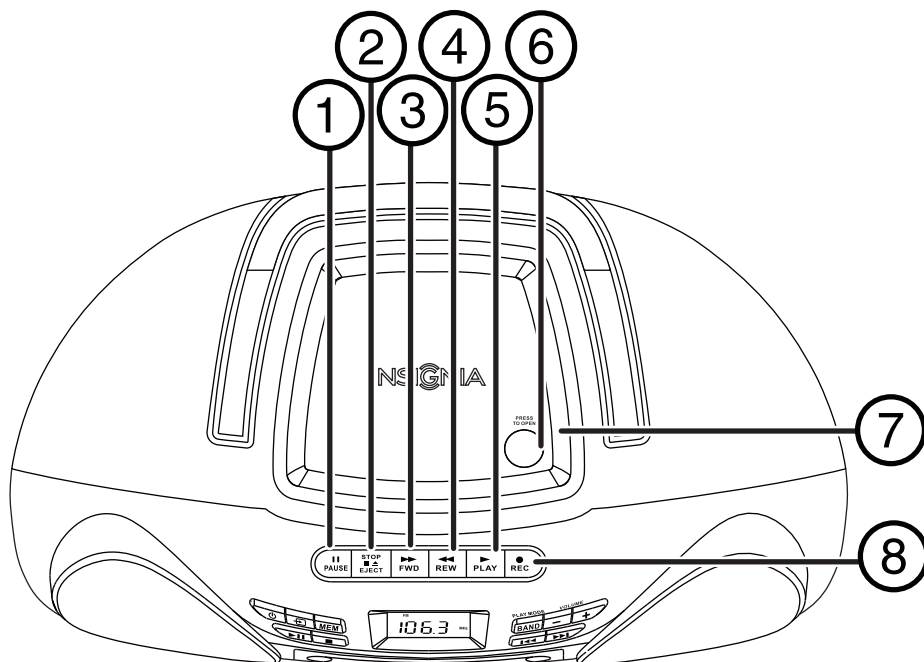

#	Description	Function
1	PAUSE button	Press to pause the tape playback. Press again to resume playback.
2	■ STOP/ ▲ EJECT button	Press to stop cassette tape playback. Press again to open the cassette door.
3	▶▶ FWD button	Press to fast forward the cassette tape.
4	◀◀ REW button	Press to rewind the cassette tape.
5	▶ PLAY button	Press to begin cassette tape playback.
6	PRESS TO OPEN	Press to open the CD door.
7	CD door	Open to place a CD on the spindle for playback.
8	● REC button	Press to begin cassette tape recording.

Back panel

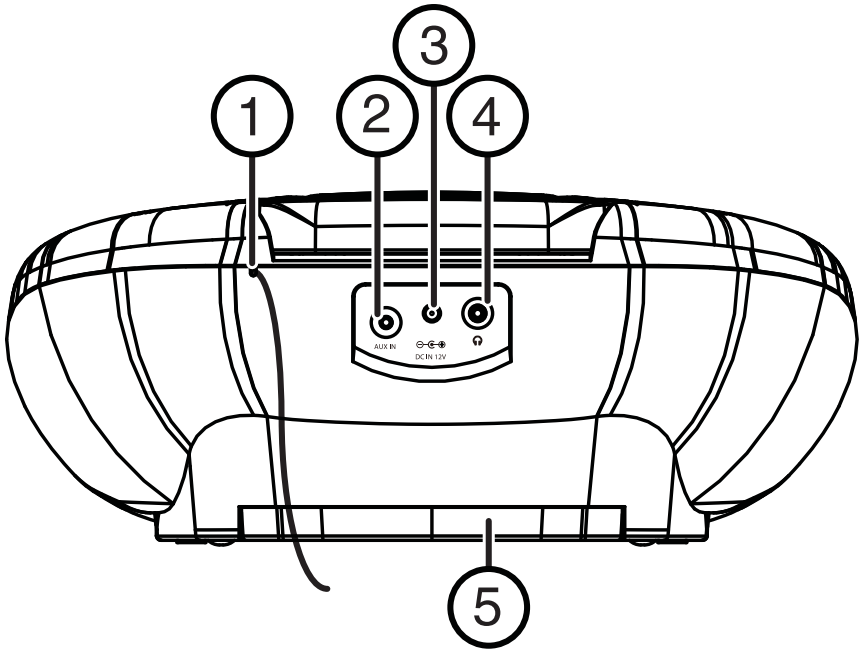

#	Description	Function
1	FM antenna wire	Provides an improved FM signal. Do not connect to an outside antenna.
2	AUX IN jack	Connect an external audio device to this jack.
3	DC IN 12V jack	Connect the AC adapter (included) to this jack to operate your boombox on AC power.
4	Headphone jack	Connect headphones to this jack to listen to radio/ playback through your headphones.
5	Battery compartment	Insert six (6) "D" sized alkaline batteries (not included) into this compartment to operate your boombox on battery power.

Display

In CD mode—the display shows the current track time elapsed (during playback), the total number of tracks (in stop mode).

In Radio mode—the display shows the preset selected and the frequency.

In Tape mode—the display shows “CAS.”

In AUX mode—the display shows “Aud.”

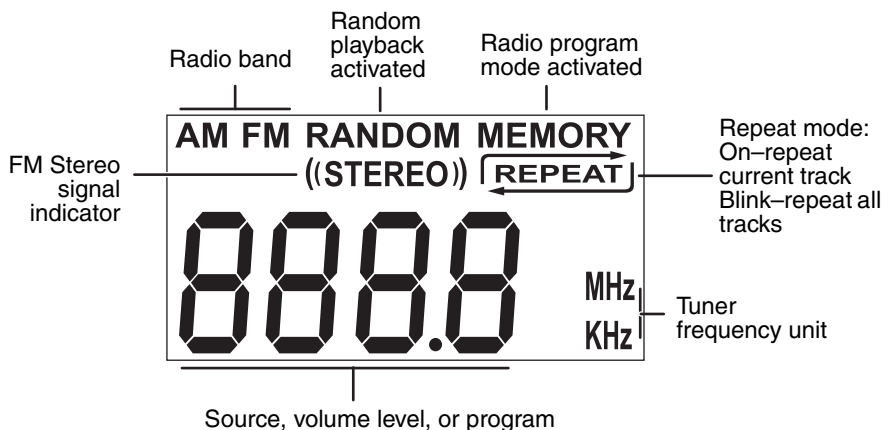

Setting up your boombox

Connecting the AC power adapter

To connect the AC power adapter:

- 1 Make sure that your local AC power source matches the voltage shown on the plate located on the AC power adapter. If it does not, consult your dealer or service center.
- 2 Insert the small connector at the end of the AC power adapter cable into the **DC IN** jack on the back of your boombox.
- 3 Plug the AC power adapter into a wall power outlet.

Caution

To protect your boombox during thunderstorms, unplug the AC power adapter from the AC power outlet.

Note

Only use the supplied AC power adapter, which has the following specifications: DC=12V 1.25A 
Unplug both the DC plug and the adapter when not in use.
The batteries are automatically bypassed when the AC power adapter is used.
- Power Adapter Electrical Specs: 100-240 V ~ 50-60 Hz, 0.7A
- Device Electrical Specs: 12 VDC, 1.25 A

Installing the batteries

To install the batteries:

- 1 Turn your boombox over, then open and remove the door to the battery compartment.
- 2 Insert six (6) “D” size batteries into the battery compartment. Make sure that you match the + and – symbols on the batteries with the + and – symbols in the battery compartment.
- 3 Reinstall and close the battery compartment door and return your boombox to the upright position.

Note

The AC power adapter must be disconnected from the DC IN jack on the back of your boombox in order for your boombox to operate on battery power.

Caution

Follow these precautions when using batteries in this device:

- Use only the size and type of batteries specified.
- Make sure that you follow the correct polarity as indicated in the battery compartment when installing batteries. Reversed batteries may cause damage to your boombox.
- Do not mix different types of batteries together (for example, alkaline, rechargeable, and carbon zinc), or semi-used batteries with fresh ones.
- If your boombox is not to be used for a long period of time, remove the batteries to prevent damage or injury from possible battery leakage.
- Do not try to recharge batteries not intended to be recharged, because they can overheat and rupture. (Follow battery manufacturer's directions.)
- Do not throw batteries into a fire. Dispose of used batteries as hazardous waste.

Connecting headphones

To connect headphones:

- Plug the headphones (not included) into the headphone jack on the back of the unit.







Caution

Listening to music with the volume too loud can damage your hearing. Before you connect headphones, turn the volume down. After you put on the headphones, gradually increase the volume to a comfortable level.

Using your boombox

Playing the radio



To play the radio:

- 1 Press  (Standby/ON) to turn on the boombox.
- 2 Press  (source) repeatedly to select **RADIO** mode, then press **BAND** to select **AM** or **FM**.
- 3 Press  (next) or  (previous) to tune the radio to a higher or lower frequency.
Press and hold  (next) or  (previous) for two seconds to automatically tune to the next or previous station.
- 4 Adjust the volume to a comfortable level by pressing either the **VOLUME +** or **VOLUME -** button.
- 5 Press  (Standby/ON) to turn off the boombox.

To improve reception:

- For FM reception, unwind and extended the FM antenna. You may have to reposition the antenna for best reception. Do not connect the FM antenna wire to an outside antenna.
- For AM reception, turn your boombox slightly until reception improves.
- Move the boombox 3 feet away from the AC power adapter to reduce interference to radio reception.

To use presets:

- 1 Press  (Standby/ON) to turn on the boombox.
- 2 Press  (source) repeatedly to select **RADIO** mode, then press **BAND** to select **AM** or **FM**.

- 3 Press **▶▶** (next) or **◀◀** (previous) to tune the radio to a higher or lower frequency.
Press and hold **▶▶** (next) or **◀◀** (previous) for two seconds to automatically tune to the next or previous station.
- 4 To save the station as a preset, press and hold the **MEM** button. “**MEMORY**” blinks on the display.
- 5 Press **▶▶** (next) or **◀◀** (previous) to select the preset number you want.
- 6 Press the **MEM** button again to confirm and store the preset.
- 7 Repeat Steps 3 to 6 to store as many as 10 AM presets and 10 FM presets.
- 8 To select a preset station, press **MEM** repeatedly until you reach the station you want.

Playing CDs

You can play standard and 3” audio CDs, CD-Rs, and CD-RWs.

Caution

Do not try to play DVDs, VCDs, or data CDs. You may damage your unit.

To play CDs:

- 1 Press **⏻** (Standby/ON) to turn on the boombox.
- 2 Press **⏮** (source) repeatedly to select **CD** mode.
- 3 Press the **PRESS TO OPEN** area on the CD door to open the lid.
- 4 Insert a CD, label side up.
- 5 Press the **PRESS TO OPEN** area on the CD door to close it. Playback begins automatically and stops when finished.
- 6 Press **■** (stop) to stop the CD before it is finished. The total number of tracks appears on the display.

Notes

If a CD is inserted incorrectly, is dirty or damaged, **ERR** appears on the display. If a CD is not present at all, **ncd** appears on the display.

To prevent damage to the CD, never open the CD door while the CD is rotating and never touch the lens.

Do not use the carrying handle when playing a CD. The CD player should only be used on a steady surface.

To pause CD playback:

- 1 Press **▶||** (play/pause). Playback stops but the CD continues to spin and the elapsed time of the current track blinks on the display.



- 2 Press ►|| (play/pause) again to resume normal CD playback.

To Skip/Search a CD track:

- 1 During playback, press ►►I (next) or I◄◄ (previous) to skip to the next or previous track, respectively.
- 2 Press and hold ►►I (next) or I◄◄ (previous) to quickly search the current track forward or backward, respectively.

Using repeat mode

To repeat one track, all tracks, or randomly play all tracks:

- 1 Press **BAND/PLAY MODE** while in playback mode to cycle through the repeat modes (**Repeat current track**, **Repeat all**, **Random**). The following appears on the display:
 -  turns on—Repeat current track
 -  blinks—Repeat all tracks
 - “**RANDOM**” turns on—Random playback
- 2 To cancel repeat mode, press **BAND/PLAY MODE** until the **Random/Repeat** icon disappears from the display.

Playing cassette tapes

To play cassette tapes:

- 1 Press ⏻ (Standby/ON) to turn on the boombox.
- 2 Press  (source) repeatedly to select **TAPE** mode. “**CAS**” appears on the display.
- 3 Press ■ STOP/ ▲ EJECT to open the cassette door.
- 4 Insert a cassette tape into the door, then gently push the door closed.

Note

Make sure to slide the cassette tape into the slot in the cassette door. Do not place the cassette tape directly onto the tape drive mechanism.









- 5 Press ◄◄ REW or ►► FWD to wind the cassette tape to the starting point you want, then press ■ STOP/ ▲ EJECT to stop the cassette tape.
- 6 Press ► PLAY to begin playback.
- 7 Press || PAUSE to pause playback. Press || PAUSE again to resume playback.
- 8 Press ■ STOP/ ▲ EJECT to stop playback. Press again to open the cassette door.

Recording to cassette tape







Note

For the best possible recording quality, only use normal bias cassette tapes (Type I).







To record to cassette tape from the radio:

- 1 Press  (Standby/ON) to turn on the boombox.
- 2 Press  (source) repeatedly to select **RADIO** mode, then press **BAND** to select **AM** or **FM**.
- 3 Insert a cassette tape into the door, then gently push the door closed.
- 4 Press  (next) or  (previous) to tune the radio to the station you want.
- 5 Press  REC and  PLAY together to begin recording.
- 6 Press  PAUSE or  STOP/  EJECT to pause or stop recording, respectively.

To record to cassette tape from a CD:



- 1 Press  (Standby/ON) to turn on the boombox.
- 2 Insert a cassette tape into the door, then gently push the door closed.
- 3 Insert a CD and close the CD door.
- 4 Press  (source) repeatedly to select **CD** mode.
- 5 Select the track to be recorded.
- 6 Press  REC and  PLAY together to begin recording.
- 7 Press  PAUSE or  STOP/  EJECT to pause or stop recording, respectively.

To record to cassette tape from AUX IN input:

- 1 Press  (Standby/ON) to turn on the boombox.
- 2 Press  (source) repeatedly to select **AUX** mode. “**Aud**” appears on the display.
- 3 Insert a cassette tape into the door, then gently push the door closed.
- 4 Start playback from the external audio device.
- 5 Press  REC and  PLAY together to begin recording.
- 6 Press  PAUSE or  STOP/  EJECT to pause or stop recording, respectively.

Listening to an external audio device

To listen to another audio device:

- 1 Make sure that the boombox is turned off.
- 2 Plug one end of the 3.5 mm AUX cable (not included) into the **AUX IN** jack on the back of your boombox.
- 3 Plug the other end of the cable into the **Line-out** jack on the audio device, such as an iPod or other MP3 player.
- 4 Press  (Standby/ON) to turn on the boombox.
- 5 Press  (source) one or more times until “**Aud**” appears on the display.
- 6 Use the controls on the audio device to control playback.

Troubleshooting

Caution

Do not try to repair the boombox yourself. Doing so will invalidate your warranty.

Problem	Solution
Your boombox will not turn on	<ul style="list-style-type: none"> • Unplug your boombox for a few moments, then plug it back in. • Make sure that the AC outlet is working by plugging another device into it.
CD player will not play	<ul style="list-style-type: none"> • Make sure that you have put a CD in the CD tray. • Make sure that the CD is inserted label side up. • Try a different CD. • Make sure that the CD player is not paused. • Make sure that the CD mode is selected. • Make sure that you are using a compatible CD. Your boombox can play standard and 3" audio CDs, CD-R, and CD-RW.
A CD skips while playing	<ul style="list-style-type: none"> • Wipe the CD with a cloth to clean it • Try a different CD. • Make sure that the CD is not warped, scratched, or damaged. • Make sure that your boombox is not being affected by vibration or shock. Move the boombox if necessary. • Make sure that you are using a compatible CD. Your boombox can play standard and 3" audio CDs, CD-R, and CD-RW.
Noise or sound distorted on AM or FM radio broadcasts	<ul style="list-style-type: none"> • Extend the FM antenna. • Rotate your boombox until the best reception is obtained. • Try turning off electrical appliances near your boombox, such as hair dryers, vacuum cleaners, or fluorescent lights.
No sound	<ul style="list-style-type: none"> • Increase the volume. • Plug in the AC power adapter and press  (Standby/ON) to turn on your boombox. • Make sure that you have installed fresh batteries and that they are installed correctly. • Make sure that you have selected the correct source. • If you are in AUX mode, make sure the volume has not been muted on your playback device.
Low volume	<ul style="list-style-type: none"> • If you are using AUX mode, make sure that the volume is turned up on both your audio source and your boombox.
A cassette tape will not play/record	<ul style="list-style-type: none"> • Open the cassette door and make sure that the tape has not been tangled in the tape drive mechanism. • Rewind your tape or turn it over to the other side.

Maintaining

Care and handling of discs

Handling discs

Do not touch the playback side of the disc. Hold the disc by the edges so that fingerprints do not get on the surface. Never stick paper or tape on the disc.

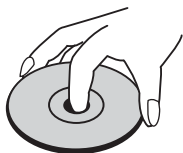

Storing discs

After playing, store the disc in its case. Do not expose the disc to direct sunlight or sources of heat and never leave it in a parked car exposed to direct sunlight.

Cleaning discs

Fingerprints and dust on the disc can cause poor sound quality and distortion. Before playing, clean the disc with a clean cloth. Wipe the disc from the center out.

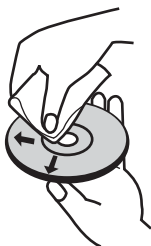

Do not use strong solvents such as alcohol, benzine, thinner, commercially available cleaners, or anti-static spray intended for older vinyl records.

Cleaning the CD lens

If your CD lens gets dirty it can cause poor sound quality. To clean the lens you will need to purchase a CD lens cleaner which can maintain the output sound quality of your system. For instructions on cleaning the CD lens, refer to the literature accompanying the lens cleaner.

Cleaning your boombox

To prevent fire or shock hazard, disconnect your boombox from the AC power source when cleaning.

The finish on your boombox may be cleaned with a dust cloth and cared for as other furniture. Use caution when cleaning and wiping the plastic parts.

Mild soap and a damp cloth may be used on the front panel.

Maintaining cassette tapes

To protect your recordings from accidental erasure on one or both sides of your cassette, snap out the tab at the top of the cassette. If you decide later to record on the tape, seal the hole with a piece of adhesive tape.

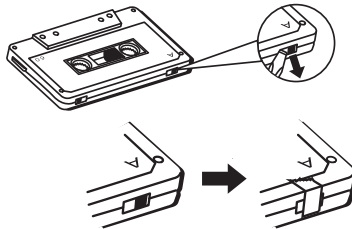

A little bit of slack in your tapes can cause scratches on the tape, or worse yet, the tape could break. If you notice some slack in the tape, use a pencil to tighten it up before you insert it.

Specifications

AC adapter input	100-240V~50/60 Hz
Power supply	12VDC, 1.25A
Radio frequency	FM: 87.5-107.9 MHz AM: 520-1710 KHz
Dimensions (HxWxD)	6.1 x 14.6 x 8.5 in. (15.4 x 37.1 x 21.7 cm)

Legal notices

FCC Statement

This device complies with Part 15 of the FCC Rules. Operation is subject to the following two conditions: (1) this device may not cause harmful interference, and (2) this device must accept any interference received, including interference that may cause undesired operation.

FCC Caution

Changes or modifications not expressly approved by the party responsible for compliance could void the user's authority to operate this equipment.

Note: This equipment has been tested and found to comply with the limits for a Class B digital device, pursuant to Part 15 of the FCC Rules. These limits are designed to provide reasonable protection against harmful interference in a residential installation. This equipment generates, uses and can radiate radio frequency energy and, if not installed and used in accordance with the instructions, may cause harmful interference to radio communications.

However, there is no guarantee that interference will not occur in a particular installation. If this equipment does cause harmful interference to radio or television reception, which can be determined by turning the equipment off and on, the user is encouraged to try to correct the interference by one or more of the following measures:

- Reorient or relocate the receiving antenna.
- Increase the separation between the equipment and receiver.
- Connect the equipment into an outlet on a circuit different from that to which the receiver is connected.
- Consult the dealer or an experienced radio/TV technician for help.

CAN ICES-3 (B)/NMB-3 (B)

This product complies with DHHS Rules 21 CFR Sub-chapter J.
Applicable at the date of manufacture.

90-day limited warranty

Insignia Products (“Insignia”) warrants to you, the original purchaser of this new **NS-BCDCAS1** (“Product”), that the Product shall be free of defects in the original manufacture of the material or workmanship for a period of 90 days from the date of your purchase of the Product (“Warranty Period”). This Product must be purchased from an authorized dealer of Insignia brand products and packaged with this warranty statement. This warranty does not cover refurbished Product. If you notify Insignia during the Warranty Period of a defect covered by this warranty that requires service, terms of this warranty apply.

How long does the coverage last?

The Warranty Period lasts for 90 days from the date you purchased the Product. The purchase date is printed on the receipt you received with the Product.

What does this warranty cover?

During the Warranty Period, if the original manufacture of the material or workmanship of the Product is determined to be defective by an authorized Insignia repair center or store personnel, Insignia will (at its sole option): (1) repair the Product with new or rebuilt parts; or (2) replace the Product at no charge with new or rebuilt comparable products or parts. Products and parts replaced under this warranty become the property of Insignia and are not returned to you. If service of Products or parts are required after the Warranty Period expires, you must pay all labor and parts charges. This warranty lasts as long as you own your Insignia Product during the Warranty Period. Warranty coverage terminates if you sell or otherwise transfer the Product.

How to obtain warranty service?

If you purchased the Product at a retail store location, take your original receipt and the Product to the store you purchased it from. Make sure that you place the Product in its original packaging or packaging that provides the same amount of protection as the original packaging. If you purchased the Product from an online web site, mail your original receipt and the Product to the address listed on the web site. Make sure that you put the Product in its original packaging or packaging that provides the same amount of protection as the original packaging.

To obtain in-home warranty service for a television with a screen 25 inches or larger, call 1-888-BESTBUY. Call agents will diagnose and correct the issue over the phone or will have an Insignia-approved repair person dispatched to your home.

Where is the warranty valid?

This warranty is valid only to the original purchaser of the product in the United States, Canada, and Mexico.

What does the warranty not cover?

This warranty does not cover:

- Customer instruction
- Installation
- Set up adjustments
- Cosmetic damage
- Damage due to acts of God, such as lightning strikes
- Accident
- Misuse
- Abuse
- Negligence
- Commercial use

- Modification of any part of the Product, including the antenna
- Plasma display panel damaged by static (non-moving) images applied for lengthy periods (burn-in).

This warranty also does not cover:

- Damage due to incorrect operation or maintenance
- Connection to an incorrect voltage supply
- Attempted repair by anyone other than a facility authorized by Insignia to service the Product
- Products sold as is or with all faults
- Consumables, such as fuses or batteries
- Products where the factory applied serial number has been altered or removed

REPAIR REPLACEMENT AS PROVIDED UNDER THIS WARRANTY IS YOUR EXCLUSIVE REMEDY. INSIGNIA SHALL NOT BE LIABLE FOR ANY INCIDENTAL OR CONSEQUENTIAL DAMAGES FOR THE BREACH OF ANY EXPRESS OR IMPLIED WARRANTY ON THIS PRODUCT, INCLUDING, BUT NOT LIMITED TO, LOST DATA, LOSS OF USE OF YOUR PRODUCT, LOST BUSINESS OR LOST PROFITS. INSIGNIA PRODUCTS MAKES NO OTHER EXPRESS WARRANTIES WITH RESPECT TO THE PRODUCT, ALL EXPRESS AND IMPLIED WARRANTIES FOR THE PRODUCT, INCLUDING, BUT NOT LIMITED TO, ANY IMPLIED WARRANTIES OF AND CONDITIONS OF MERCHANTABILITY AND FITNESS FOR A PARTICULAR PURPOSE, ARE LIMITED IN DURATION TO THE WARRANTY PERIOD SET FORTH ABOVE AND NO WARRANTIES, WHETHER EXPRESS OR IMPLIED, WILL APPLY AFTER THE WARRANTY PERIOD. SOME STATES, PROVINCES AND JURISDICTIONS DO NOT ALLOW LIMITATIONS ON HOW LONG AN IMPLIED WARRANTY LASTS, SO THE ABOVE LIMITATION MAY NOT APPLY TO YOU. THIS WARRANTY GIVES YOU SPECIFIC LEGAL RIGHTS, AND YOU MAY ALSO HAVE OTHER RIGHTS, WHICH VARY FROM STATE TO STATE OR PROVINCE TO PROVINCE.

Contact Insignia:

For customer service, call 1-877-467-4289 (U.S. and Canada) or

01-800-926-3000 (Mexico)

www.insigniaproducts.com

Distributed by Best Buy Purchasing, LLC

7601 Penn Avenue South, Richfield, Minnesota, U.S.A. 55423-3645

© 2013 BBY Solutions, Inc.

All rights reserved. INSIGNIA is a trademark of BBY Solutions, Inc. Registered in some countries. All other products and brand names are trademarks of their respective owners.



www.insigniaproducts.com 1-877-467-4289 (U.S. and Canada) or 01-800-926-3000 (Mexico)

Distributed by Best Buy Purchasing, LLC
7601 Penn Avenue South, Richfield, MN USA 55423-3645
© 2013 BBY Solutions, Inc.

All rights reserved. INSIGNIA is a trademark of BBY Solutions, Inc. Registered in some countries.
All other products and brand names are trademarks of their respective owners.

V1 ENGLISH
13-0709